

5 51 854 0

basis Iceberg







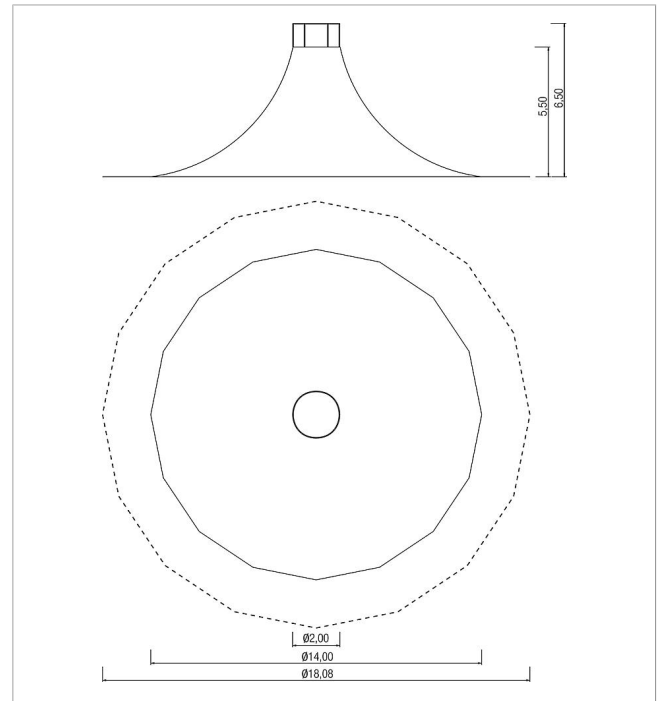

made in germany



Scope of delivery

- 1x mountain platform: galvanised steel
- 1x mountain substructure: galvanised steel
- 1x iceberg covering: PVC-tarpaulin, UV-stable, tear-resistant
- 2x climbing rope: plastic-coated steel cable
- 120x rubberised climbing handles: rubber
- 1x climbing ladder: plastic-coated steel cable
- 125qm fall protection panels: rubber granulate
- 45x edge panel: rubber granulate



	Material	PVC
	Foundation level	FL 3
	Minimum space	Ø 1808x730 cm
	Free falling height	100 cm
	Impact protection net	110,0 m ²
	Foundations	6x CF
	Assembly	3 persons/25 h
	Largest section	210x210x300 cm
	Heaviest section	500 kg