



5 59 098 0

## Basis Palisade sandpit side sections







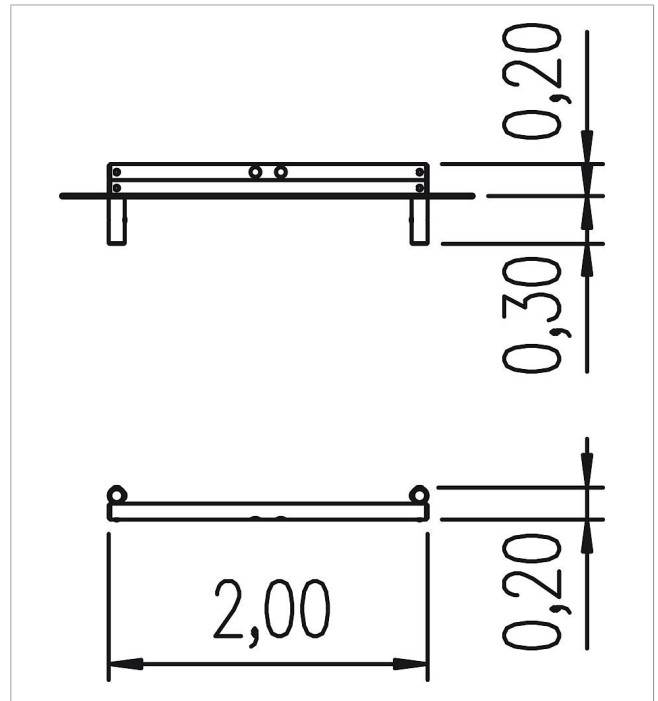

made in germany



### Scope of delivery

1x side part L 200 cm: SW



	Material	SW pi
	Foundation level	-
	Minimum space	200x20x200 cm
	Free falling height	20 cm
	Impact protection net	-
	Foundations	-
	Assembly	1 person/0.3 h
	Largest section	200x20x60 cm
	Heaviest section	20 kg