

5 59 060 0

Basis Sand pit Hygipäd







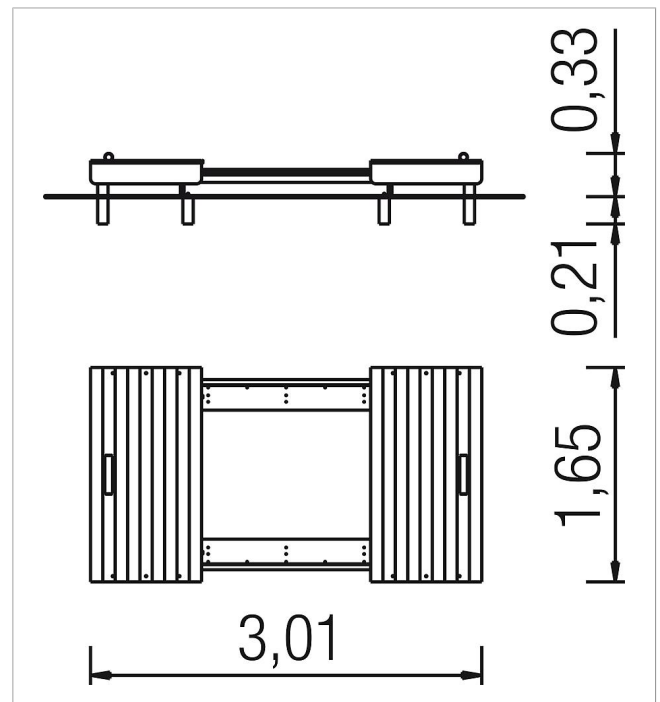

made in germany



Scope of delivery

1x sand pit: SW pi



	Material	SW pi
	Foundation level	-
	Minimum space	301x165x213 cm
	Free falling height	33 cm
	Impact protection net	-
	Foundations	-
	Assembly	-
	Largest section	300x8x6 cm
	Heaviest section	50 kg