

5 40 104 1210 0

**Basis Add-on slide
wide stainless steel,
ph 145 cm**







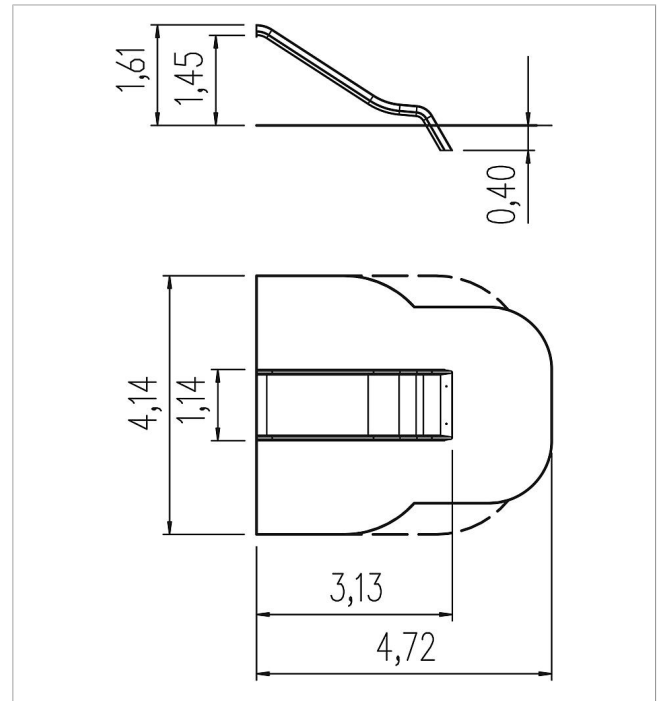

made in germany

3+

Scope of delivery

1 wide slide PH 145 cm: stainless steel



	Material	Stainless steel
	Foundation level	FL 1
	Minimum space	472x414x325 cm
	Free falling height	145 cm
	Impact protection net	17,0 m ²
	Foundations	1x CF or 1x PFs
	Assembly	2 persons/1 h
	Largest section	375x114x45 cm
	Heaviest section	125 kg