



5 55 276 025

## unique aerial cable way Fjall 30 m







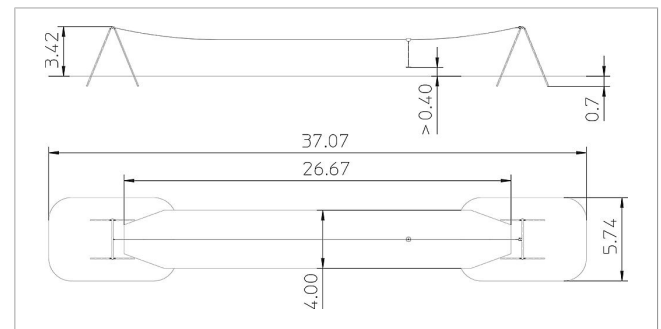

made in germany



### Scope of delivery

- 1x rope anchor: galvanised steel
- 1x rope tensioning device: galvanised steel
- 1x cableway cart: stainless steel
- 1x carrying rope L 30 m: steel cable
- 2x impact spring: spring steel
- 1x swing seat: rubber
- base structure: galvanised and powder-coated steel



	Material	Steel powder, grey
	Foundation level	FL 3
	Minimum space	3707x574x342 cm
	Free falling height	80 cm
	Impact protection net	112,0 m <sup>2</sup>
	Foundations	8x CF
	Assembly	2 persons/5 h
	Largest section	450xØ 9 cm
	Heaviest section	60 kg