

5 55 304 5

## balance Quick Step Criss-Cross







made in germany

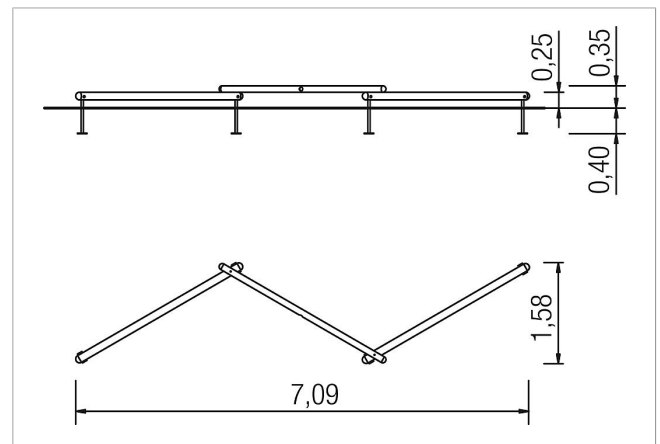

### Scope of delivery

1x Quick Step: SW  
4x post shoe: galvanised steel



	Material	SW pi
	Foundation level	FL 1
	Minimum space	709x158x215 cm
	Free falling height	35 cm
	Impact protection net	-
	Foundations	4x CF or 4x PFs
	Assembly	1 person/2 h
	Largest section	300xØ 12 cm
	Heaviest section	24 kg