

5 55 316 5

balance Samba net footbridge







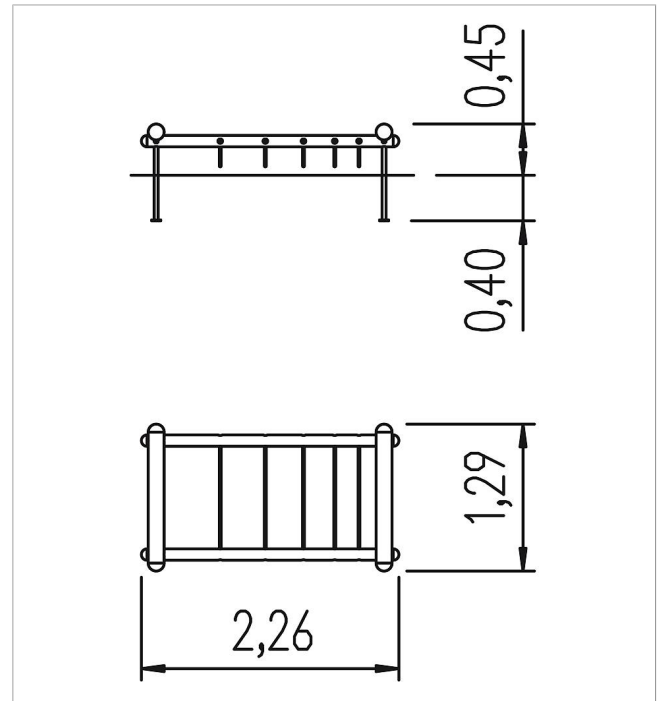

made in germany



Scope of delivery

- 5x ropes: plastic-coated steel cable
- 1x wood structure: SW
- 4x post shoe: galvanised steel



	Material	SW pi
	Foundation level	FL 1
	Minimum space	226x129x225 cm
	Free falling height	45 cm
	Impact protection net	-
	Foundations	4x CF or 4x PFs
	Assembly	1 person/2 h
	Largest section	226xØ 10 cm
	Heaviest section	12,5 kg