



5 55 315 5

balance tibetan bridge Jive







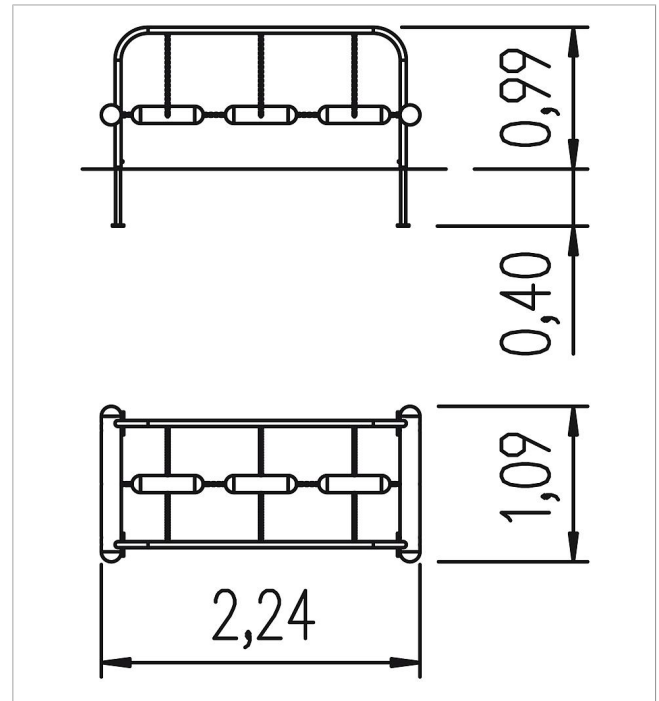

made in germany



Scope of delivery

- 2x handrails: stainless steel
- 1x chain suspensions: galvanised steel
- 2x cross-beam supports: SW
- 3x stepping beams: SW



	Material	SW pi
	Foundation level	FL 1
	Minimum space	224x109x225 cm
	Free falling height	45 cm
	Impact protection net	-
	Foundations	4x CF or 4x PFs
	Assembly	1 person/2 h
	Largest section	242x116xØ 42 cm
	Heaviest section	40 kg