

5 10 014 0410 0

## playo balancing station Terraserpe







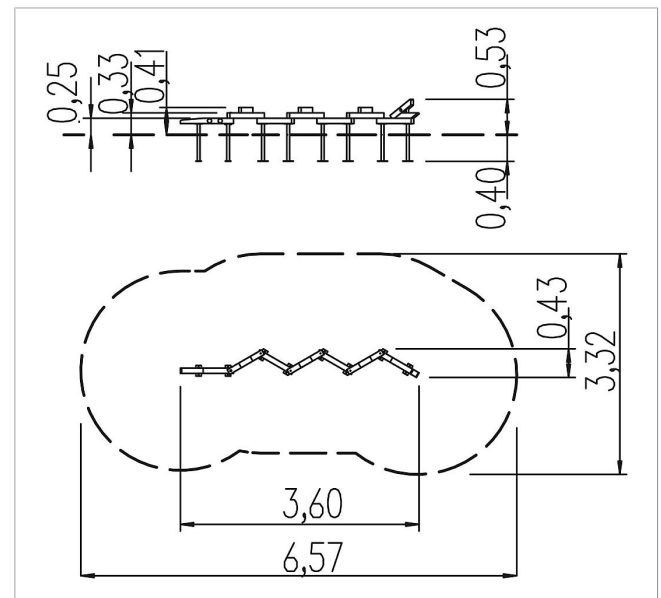

made in germany



### Scope of delivery

- 1x pre-installed head part: SW
- 3x pre-installed middle parts: SW
- 2x bottom parts: SW
- 1x end part: SW
- 8x post bases: galvanised steel



	Material	Larch GL
	Foundation level	FL 1
	Minimum space	657x332x233 cm
	Free falling height	53 cm
	Impact protection net	-
	Foundations	4x CF or 8x PFs
	Assembly	1 person/2 h
	Largest section	69x36x8 cm
	Heaviest section	5 kg