



5 62 051 0







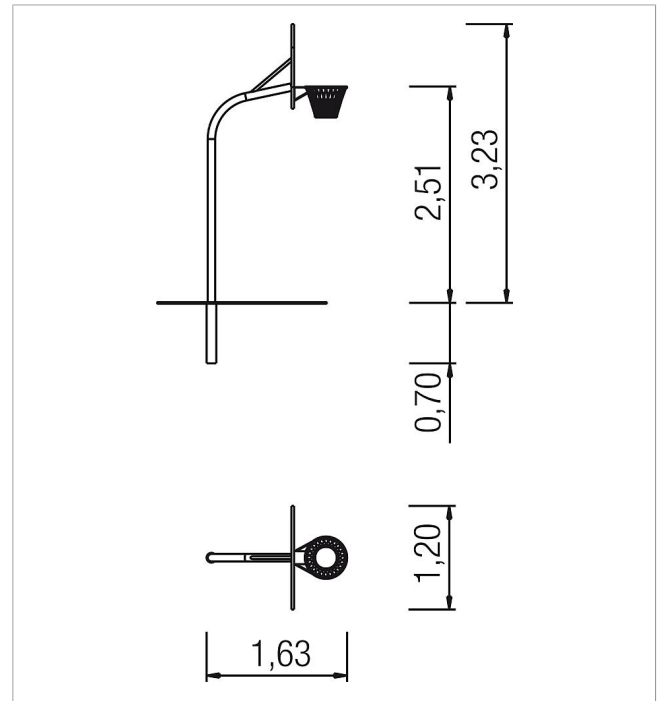

fit Basketball system
steel tube with ground
sleeve
made in germany



Scope of delivery

- 1x goal board 120x90 cm: GFRP
- 1x basket: galvanised and powder-coated steel
- 1x chain net: galvanised steel
- 1x posts L 323 cm: galvanised and powder-coated steel
- 1x ground sleeve: galvanised steel



	Material	Steel, GFRP
	Foundation level	FL 3
	Minimum space	163x120x323 cm
	Free falling height	-
	Impact protection net	-
	Foundations	1x CF
	Assembly	2 persons/1 h
	Largest section	120x70x10 cm
	Heaviest section	75 kg