

5 25 910 0410 0

## climbo climbing structure Kaya







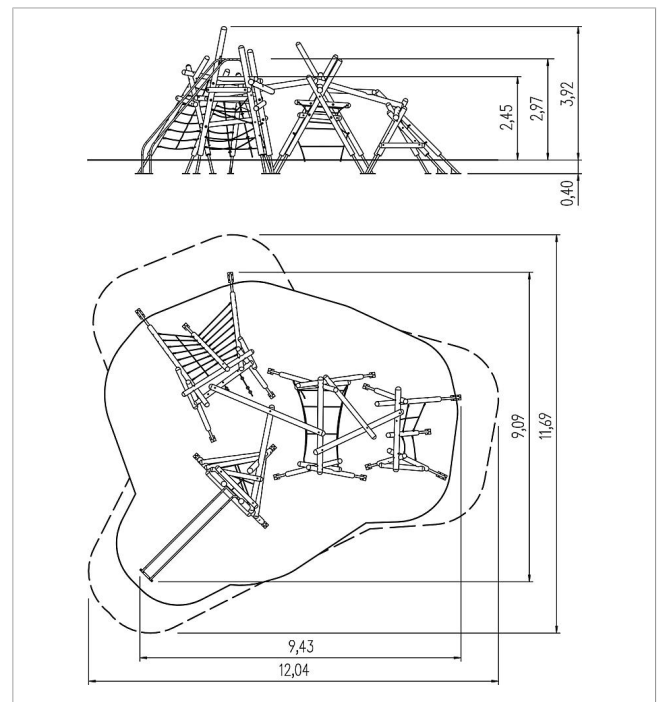

made in germany



### Scope of delivery

- 36x post structure: SW
- 17x post shoe: galvanised steel
- 5x net ascent: plastic-coated steel cable, stainless steel
- 3x rope ascent sloped: plastic-coated steel rope, stainless steel
- 1x hand rail slide: stainless steel



	Material	Larch GL
	Foundation level	FL 1
	Minimum space	1204x1169x392 cm
	Free falling height	297 cm
	Impact protection net	72,5 m <sup>2</sup>
	Foundations	15x CF or 13 PFI + 2x PFs
	Assembly	2 Personen/12 Std.
	Largest section	Ø14x495 cm
	Heaviest section	65 kg