



5 25 909 0310 0

## climbo climbing structure Yuna







made in germany

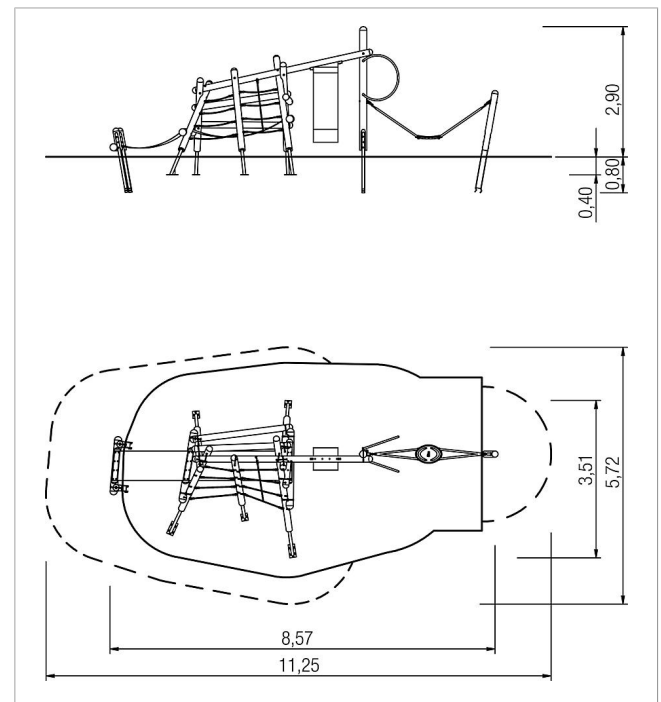

### Scope of delivery

- 16x post structure: SW
- 9x post shoe: galvanised steel
- 1x net ascent sloped: plastic-coated steel cable, stainless steel
- 1x rope ascent sloped: plastic-coated steel cable, stainless steel
- 1x hammock: belt strap, stainless steel
- 1x loop seat: belt strap, SW, stainless steel
- 2x hinge: stainless steel
- 1x Curver seat: rubber, galvanised steel
- 2x hand rail: stainless steel



	Material	Larch natural
	Minimum space	1125x572x420 cm
	Free falling height	240 cm
	Impact protection net	32,5 m <sup>2</sup>
	Foundations	9x CF or 5x PFI + 4x CF
	Assembly	2 Personen/8 Std.
	Largest section	Ø 14x410 cm
	Heaviest section	55 kg