

5 52 019 1430 9

Basis Climbing unit TeenCity Atlas







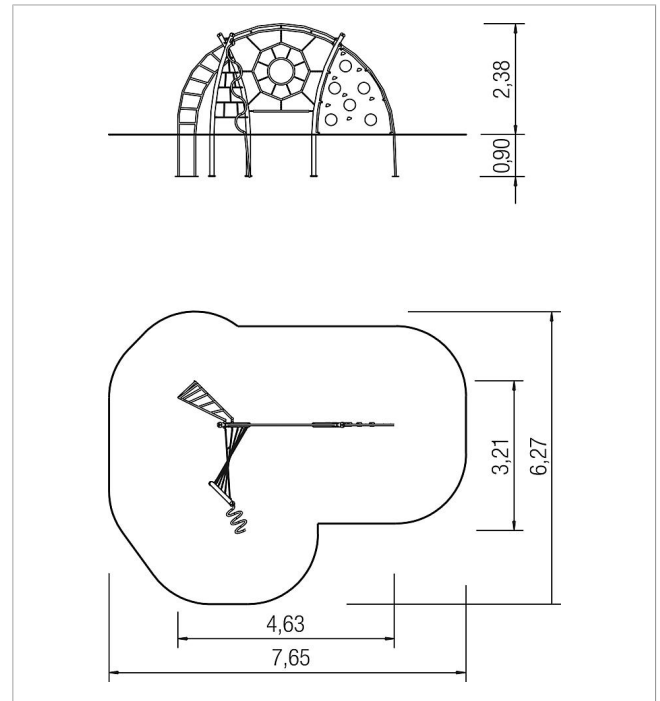

made in germany



Scope of delivery

- 3x posts: galvanised and powder-coated steel
- 1x chain net octagon: stainless steel
- 1x climbing net: plastic-coated steel cable
- 1x climbing snake: stainless steel
- 1x climbing wall, grips: HPL, GFRP
- 1x ladder access twisted: stainless steel
- 3x post cover: PA6



	Material	Steel powder. iguana
	Foundation level	FL 3
	Minimum space	765x627x418 cm
	Free falling height	238 cm
	Impact protection net	37,0 m ²
	Foundations	6x CF
	Assembly	2 persons/6 h
	Largest section	160x40x320 cm
	Heaviest section	40 kg