



5 25 044 7710 0

active trail
combination 05







made in germany

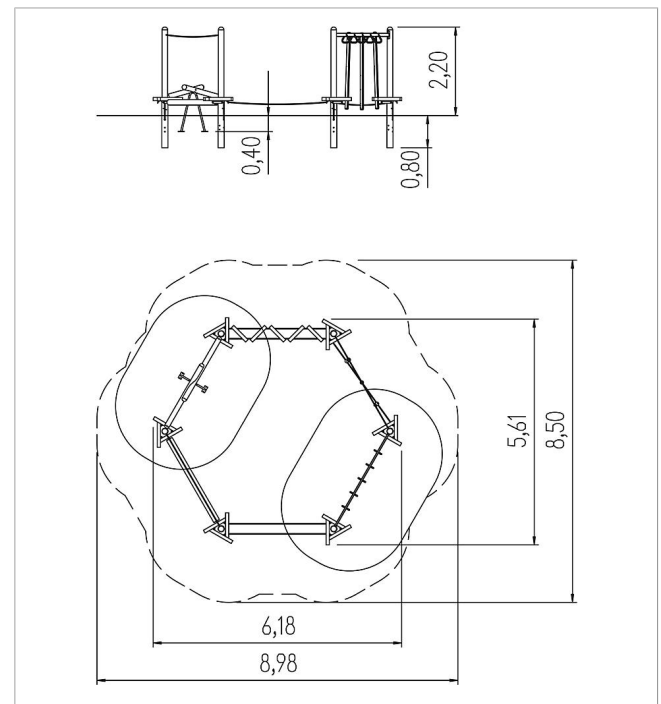

Scope of delivery

- 6x island
- 1x crossing L3
- 1x crossing L4
- 1x crossing M5
- 1x crossing M6
- 1x crossing S5
- 1x crossing S6



	Material	Stainless steel, Eucalyptus
	Foundation level	FL 3
	Minimum space	898x850x320 cm
	Free falling height	83 cm
	Impact protection net	29,5 m ²
	Foundations	8x CF
	Heaviest section	80 kg