

5 59 805 5

minimondo crawling bridge







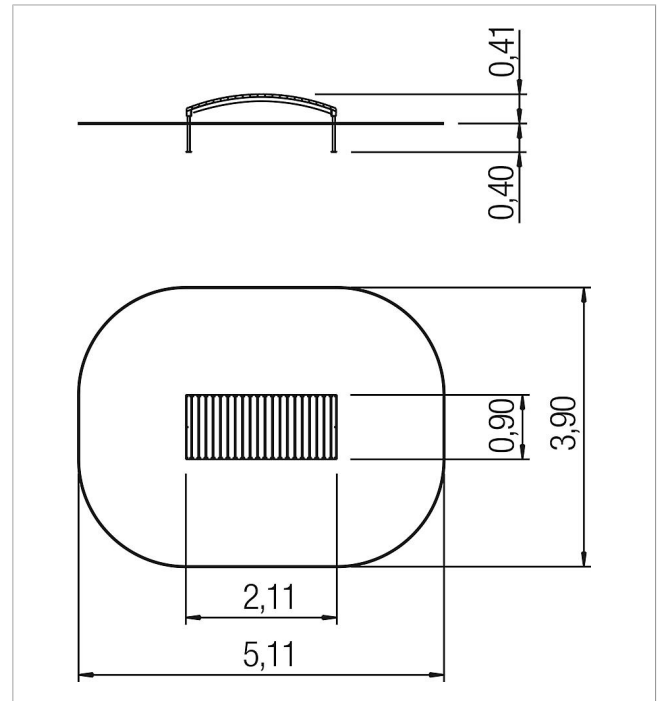

made in germany



Scope of delivery

1x crawling bridge: SW
post bases: galvanised steel



	Material	SW pi
	Foundation level	FL 1
	Minimum space	511x390x221 cm
	Free falling height	41 cm
	Impact protection net	18,0 m ²
	Foundations	4x CF or 2x PFs
	Assembly	2 persons/1 h
	Largest section	210x90x32 cm
	Heaviest section	30 kg