



5 55 139 5

unique double swing Crane

made in germany











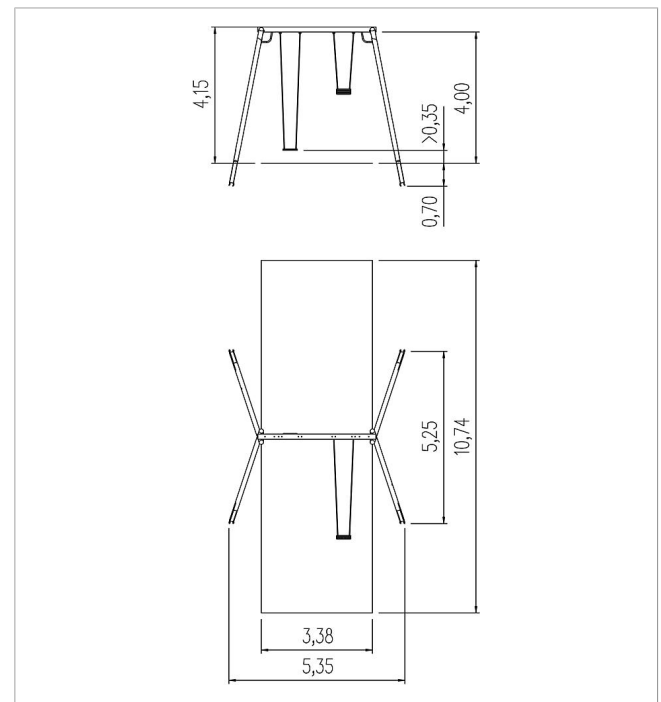

Scope of delivery

1x swing frame: SW, galvanised steel

2x swing seat: galvanised steel, rubber, stainless steel

post shoes: galvanised steel



	Material	SW pi
	Foundation level	FL 3
	Minimum space	1074x535x415 cm
	Free falling height	220 cm
	Impact protection net	36,5 m ²
	Foundations	4x CF
	Assembly	2 persons/2.5 h
	Largest section	454xØ 14 cm
	Heaviest section	50 kg