



5 15 002 1330 0

**ecorino double swing  
with nest seat Ø 100  
cm**







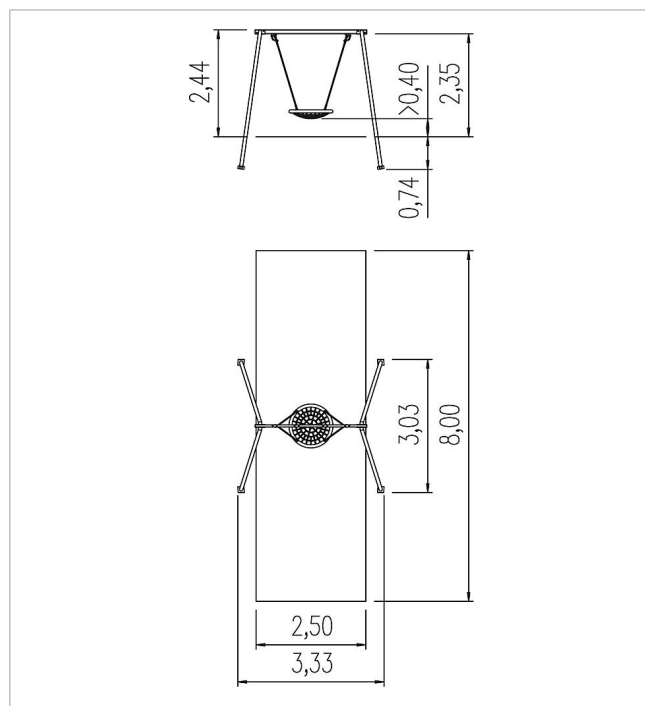

made in germany

3+

### Scope of delivery

swing frame: galvanised steel  
set of swing joints: galvanised steel  
nest seat Ø 100 cm: galvanised steel, polyester-coated steel cable



	Material	Steel
	Foundation level	FL 3
	Minimum space	333x800x368 cm
	Free falling height	146 cm
	Impact protection net	20,0 m <sup>2</sup>
	Foundations	4x CF
	Assembly	2 persons/2 h
	Largest section	343x22x13 cm
	Heaviest section	22 kg