

5 55 070 024

Basis Hammock with metal posts







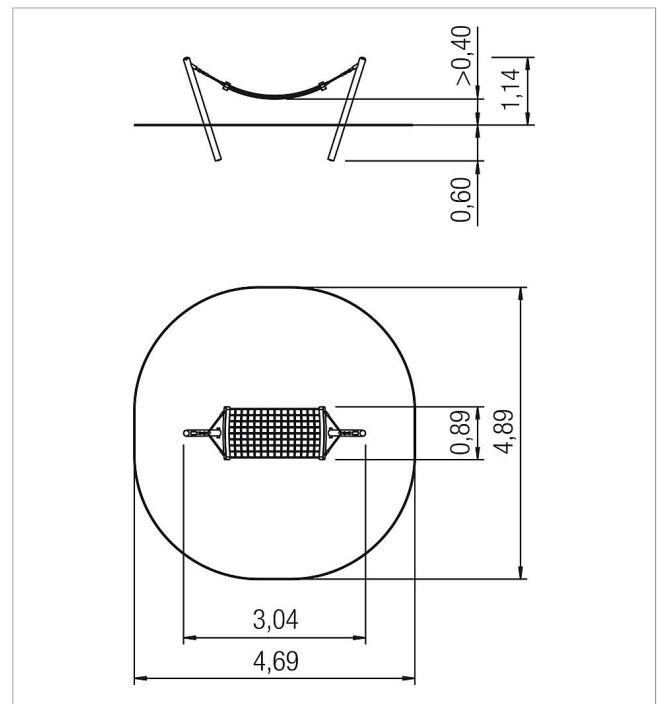

made in germany



Scope of delivery

set of posts: galvanised and powder-coated steel
hammock with joints: polyester-coated steel cable, SW pi
post cover PA6



	Material	Steel powder. blue
	Foundation level	FL 3
	Minimum space	489x469x223 cm
	Free falling height	70 cm
	Impact protection net	19,5 m ²
	Foundations	2x CF
	Assembly	2 persons/1 h
	Largest section	181x16x10 cm
	Heaviest section	50 kg