



5 52 024 1430 9

unique hexagonal swing







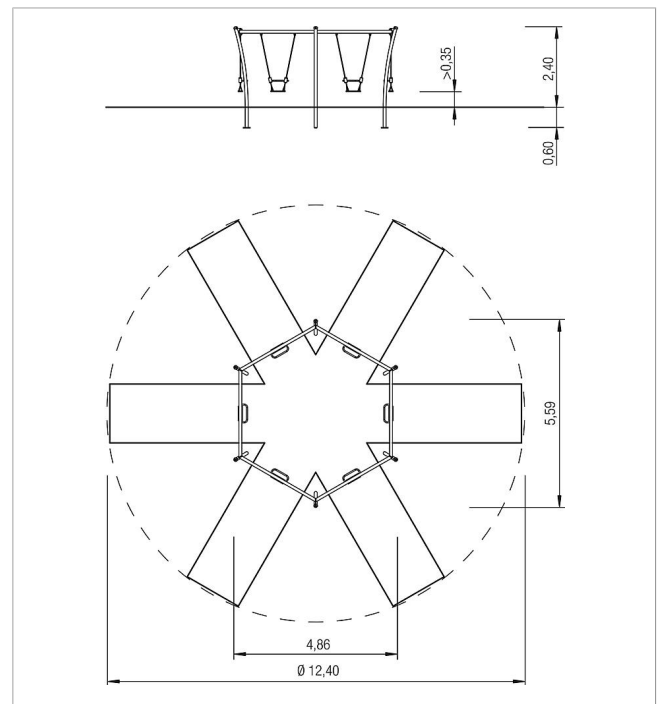

made in germany



Scope of delivery

- 1x swing frame: galvanised and powder-coated steel
- 6x swing seats: safety swing seat with jump-off protection and VA-stainless steel chain
- 12x swing joint: POM-bearing, stainless steel
- 6x post cover: PA6



	Material	Steel powder. iguana
	Foundation level	FL 3
	Minimum space	$\varnothing 1240 \times 320$ cm
	Free falling height	149 cm
	Impact protection net	121,0 m ²
	Foundations	6x CF
	Assembly	2 persons/5 h
	Largest section	305x30x10 cm
	Heaviest section	40 kg