



5 45 233 5

Basis Hill platform for wide wave slide







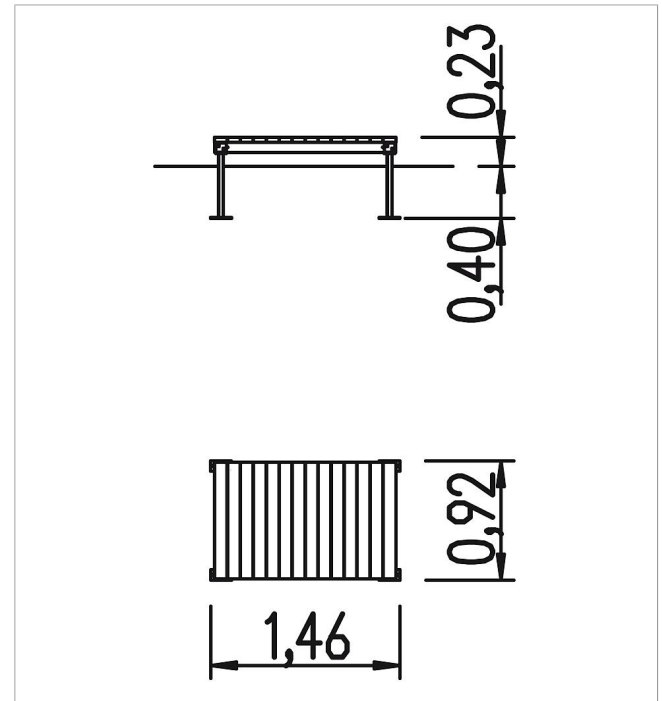

made in germany

3+

Scope of delivery

1 hill platform: SW pi
post shoes: galvanised steel



	Material	SW pi
	Foundation level	FL 1
	Minimum space	146x92x203 cm
	Free falling height	23 cm
	Impact protection net	-
	Foundations	4x CF or 4x PFs
	Assembly	1 person/1 h
	Largest section	140x90x12 cm
	Heaviest section	45 kg