



5 59 116 0

playo large train Locomotive







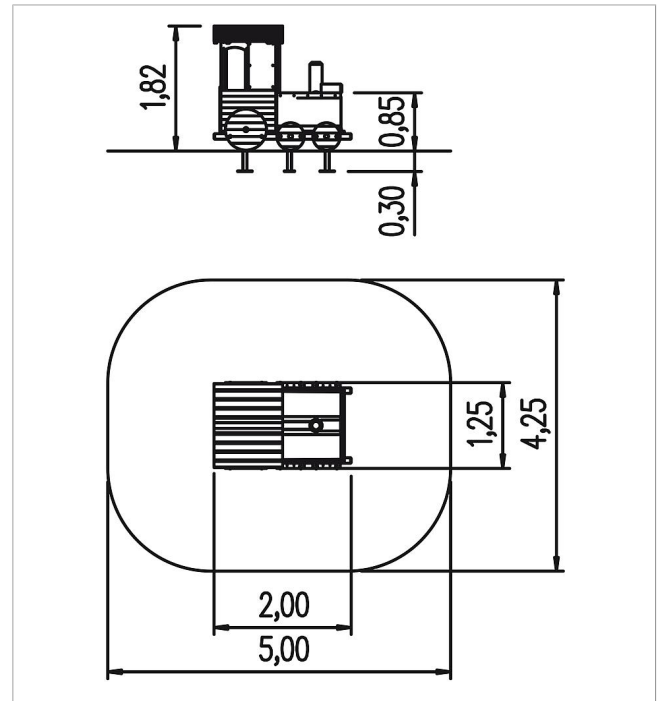

made in germany



Scope of delivery

- 1x half-shell: GFRP
- 1x operator's cab: HPL
- 6x wheels: SW
- 1x platform bottom operator's cab: SW
- 1x roof: SW
- 1x chimney: SW



	Material	SW pi
	Foundation level	-
	Minimum space	500x425x265 cm
	Free falling height	85 cm
	Impact protection net	19,5 m ²
	Foundations	-
	Assembly	2 persons/6 h
	Largest section	212x110x50 cm
	Heaviest section	140 kg