



5 45 297 0610 0

paradiso motor activity station Amelie







made in germany

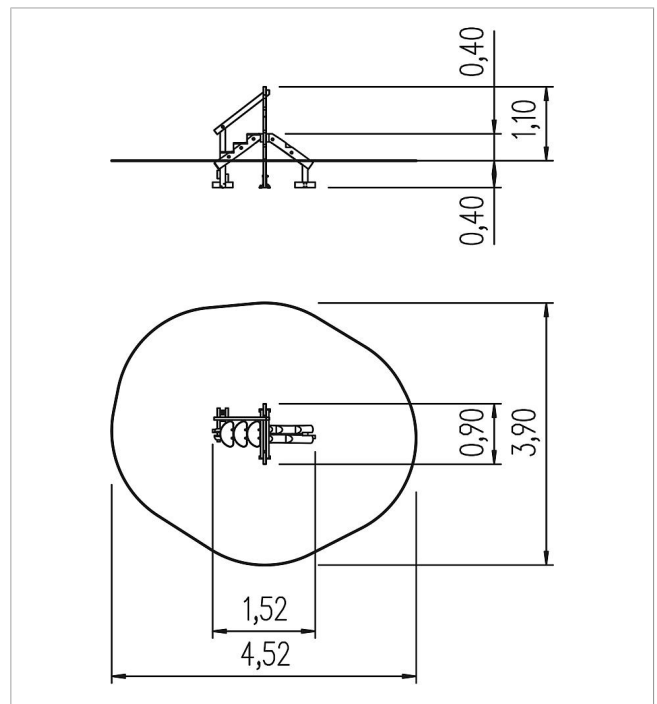

Scope of delivery

- 2x post structure: robinia
- 6x mounting brackets: steel
- 1x ascent with timber steps: robinia, HPL
- 1x double log ascent with grooved steps: robinia
- 1x handrail: robinia



	Material	Robinia natural
	Foundation level	FL 1
	Minimum space	452x390x220 cm
	Free falling height	40 cm
	Impact protection net	13,5 m ²
	Foundations	3x PFs
	Assembly	-