

5 66 508 0410 0







**unique
mountaineering ramp
Baku**
made in germany

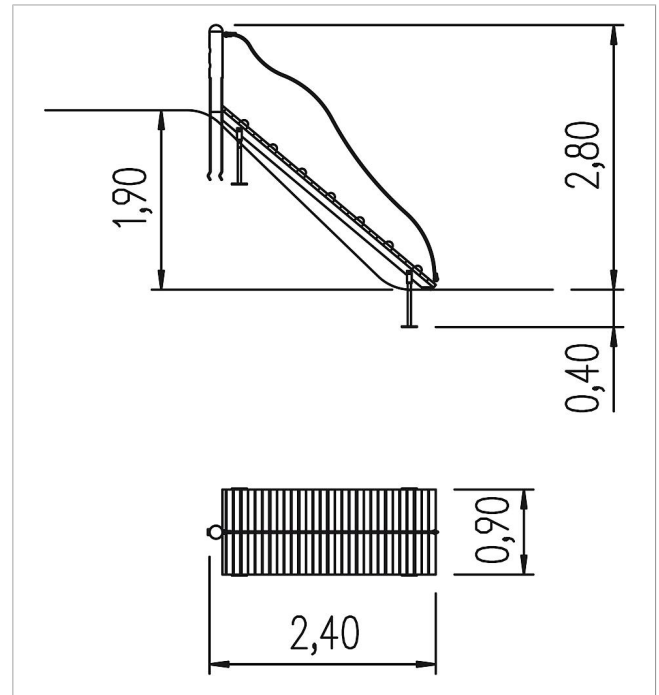

Scope of delivery

1x mountaineer's ramp: SW
1x palisade: SW
1x rope: polyester-coated steel cable
post shoes: galvanised steel



	Material	Larch
	Foundation level	FL 1
	Minimum space	244x90x370 cm
	Free falling height	-
	Impact protection net	-
	Foundations	5x CF or 4x PFs + 1x CF
	Assembly	2 persons/1 h
	Largest section	292x90x12 cm
	Heaviest section	60 kg