

5 67 122 0

playo multi-spring rocker Sand raft







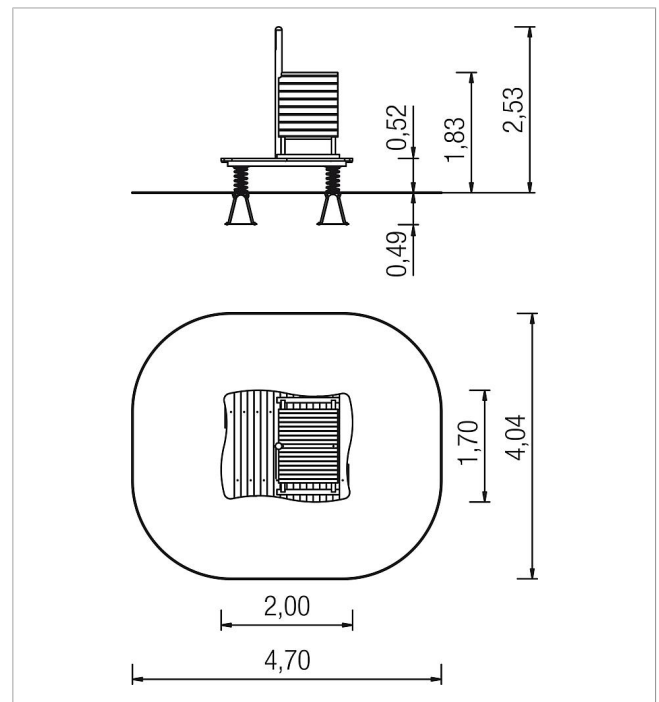

made in germany



Scope of delivery

- 1x raft: SW
- 1x roof: SW
- 4x springs: spring steel
- 1x mast: SW
- 1x flag: HPL



| | | |
|---|-----------------------|---------------------|
|  | Material | SW pi |
|  | Foundation level | FL 3 |
|  | Minimum space | 470x404x253 cm |
|  | Free falling height | 52 cm |
|  | Impact protection net | 17,0 m ² |
|  | Foundations | 4x 5632280 + 4x CF |
|  | Assembly | 2 persons/2 h |
|  | Largest section | 200x170x11 cm |
|  | Heaviest section | 20 kg |