

5 67 120 0

Basis Multi-spring rocker Covered Wagon







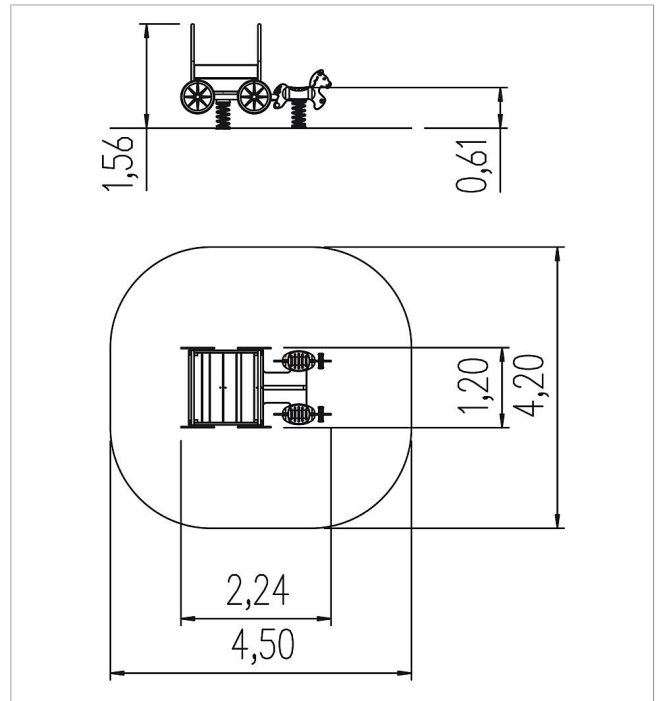

made in germany



Scope of delivery

4x wheels: HPL
 2x holding bracket: galvanised and powder-coated steel
 2x spring see-saw body: PE
 4x springs: spring steel
 base structure: SW



	Material	SW pi
	Foundation level	FL 3
	Minimum space	450x420x264 cm
	Free falling height	84 cm
	Impact protection net	15,0 m ²
	Foundations	4x 5632280 + 4x CF
	Assembly	2 persons/1.5 h
	Largest section	112x112x118 cm
	Heaviest section	70 kg