

5 67 233 0

Basis Multi-spring rocker Dolphin and Whales







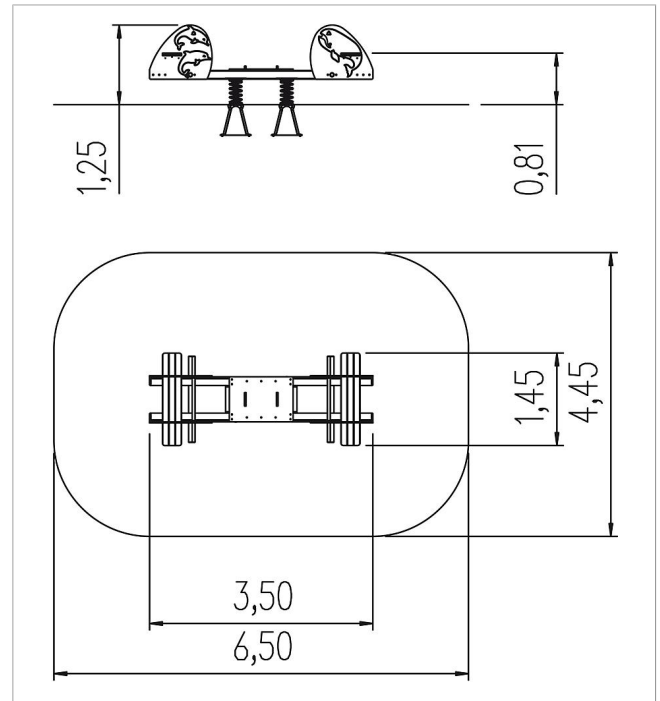

made in germany



Scope of delivery

1x spring see-saw-body: SW, HPL
4x springs: spring steel



	Material	SW pi, HPL
	Foundation level	FL 3
	Minimum space	650x445x261 cm
	Free falling height	81 cm
	Impact protection net	26,5 m ²
	Foundations	4x 5632280 + 4x CF
	Assembly	2 persons/1.5 h
	Largest section	350x130x89 cm
	Heaviest section	110 kg