



5 25 018 1900 0

active trail parallel balancing ropes S6







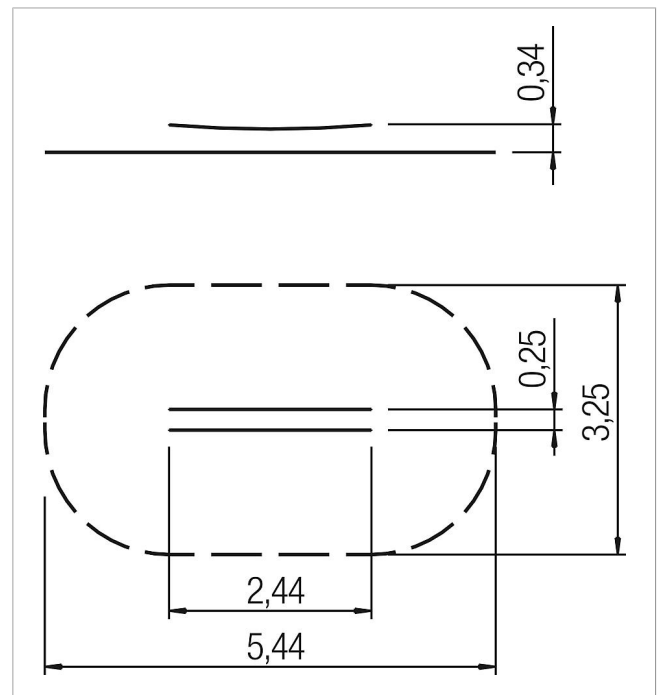

made in germany



Scope of delivery

1x double rope: plastic-coated steel cable



	Material	PP steel cable
	Foundation level	-
	Minimum space	544x325x214 cm
	Free falling height	34 cm
	Impact protection net	-
	Foundations	-
	Assembly	1 person/4.5 h
	Largest section	-
	Heaviest section	2 kg