

5 10 018 0110 0

## playo play course Terracombi midi







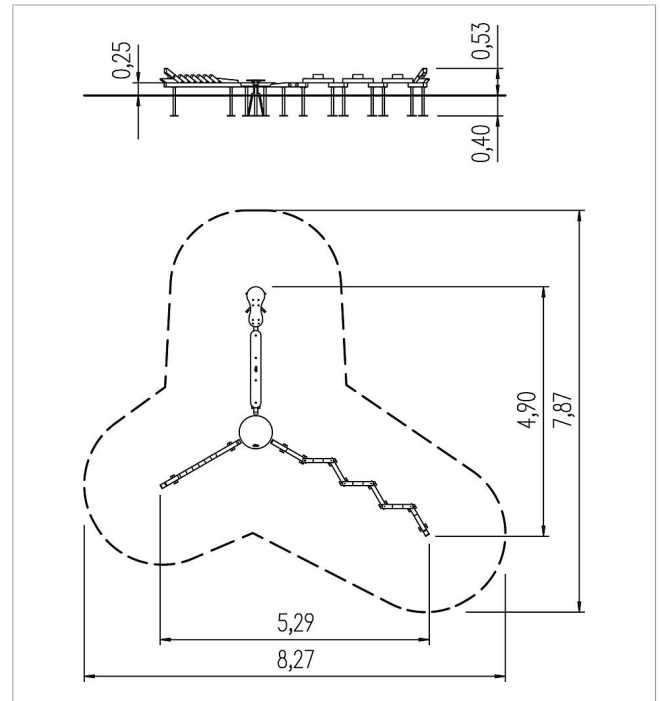

made in germany



### Scope of delivery

- 1x balancing snake Terraserpe: SW
- 1x balancing station Terratrampolino: SW, HPL
- 1x balancing station Terracocodrillo: SW
- 1x balancing platform Terrapodio: HPL



	Material	SW pi
	Foundation level	FL 1
	Minimum space	822x787x233 cm
	Free falling height	53 cm
	Impact protection net	9,0 m <sup>2</sup>
	Foundations	7x CF or 17x PFs
	Assembly	1 person/4 h
	Largest section	187x8x8 cm
	Heaviest section	20 kg