



5 59 011 5

## playo play house Alexander







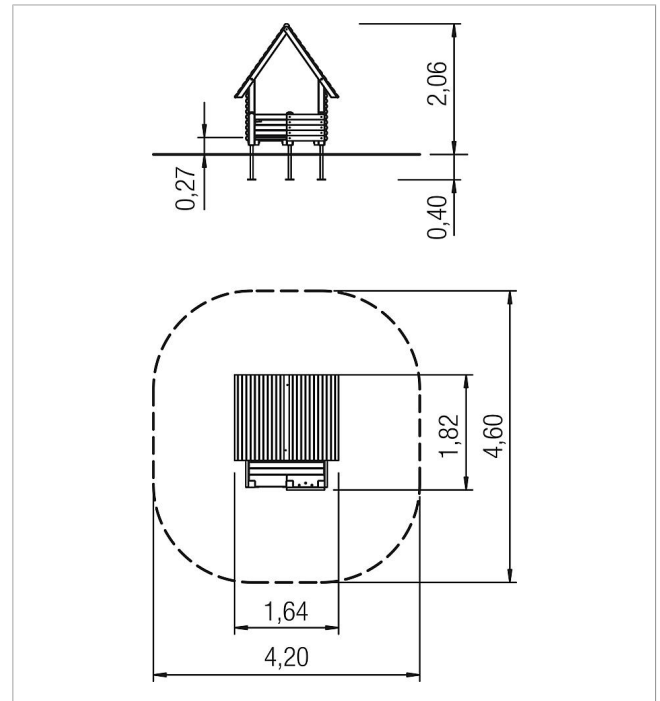

made in germany

1+

### Scope of delivery

set of posts with post bases: SW, galvanised steel  
set of benches: SW  
play house: SW



	Material	SW pi
	Foundation level	FL 1
	Minimum space	460x420x206 cm
	Free falling height	27 cm
	Impact protection net	-
	Foundations	7x CF or 5x PFs
	Assembly	2 persons/1 h
	Largest section	160x120x13 cm
	Heaviest section	25 kg