



5 59 850 0110 0

## minimondo play unit Concrete Mixer







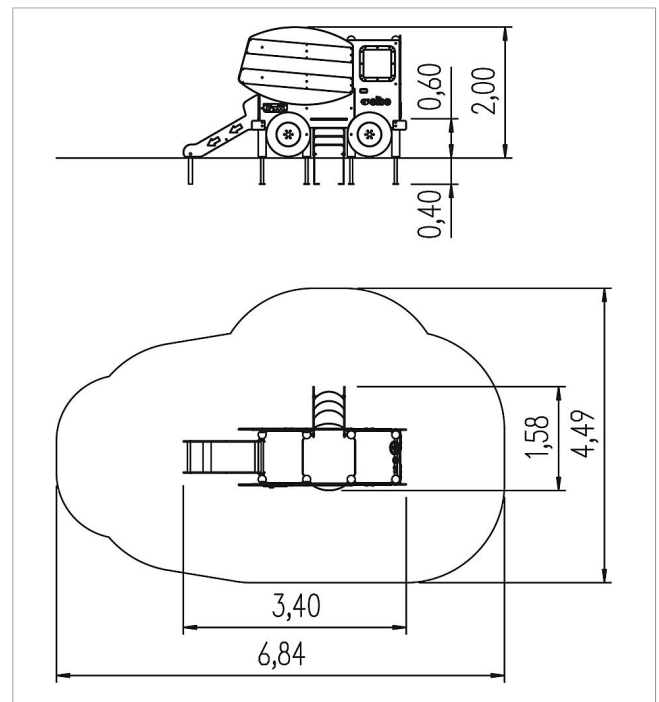

made in germany



### Scope of delivery

- 1x slide: HPL, stainless steel
- 1x stair: HPL
- 3x platform surface: HPL
- 2x panel with window: HPL, Makrolon
- 1x panel with lights: HPL, Plexiglas
- 1x playing panel mirror: HPL, Plexiglas
- 1x playing panel control console: SW, HPL
- 1x playing panel lever: HPL, stainless steel
- 1x set posts with post bases: SW, galvanised steel



	Material	SW pi
	Foundation level	FL 1
	Minimum space	684x449x240 cm
	Free falling height	60 cm
	Impact protection net	24,5 m <sup>2</sup>
	Foundations	3x CF or 2x PFs + 8x PFr
	Largest section	Ø 12x226 cm
	Heaviest section	55 kg