



5 25 082 0110 0

unique play unit
Extron, solo







made in germany

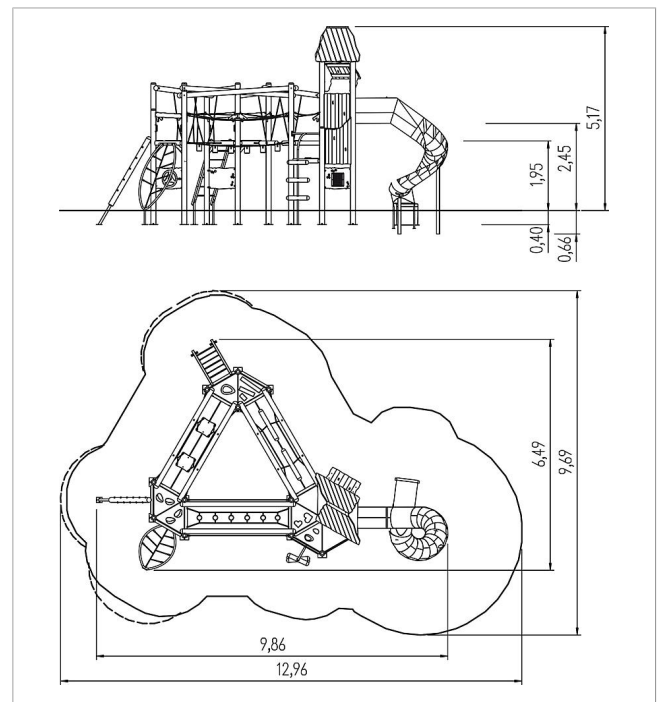

Scope of delivery

- 15x post construction: SW or steel
- 5x platform construction: galvanised steel
- 2x platform leaf: HPL
- 1x platform heart: HPL
- 1x platform squared timber: HPL, SW
- 1x platform grass: HPL
- 1x platform stone: HPL
- 4x platform: HPL
- 1x 3D parapet: SW, HDPE
- 9x wall panel: SW
- 1x leaf ascent: stainless steel, polyester-coated steel cable
- 1x rotating trunk ascent: SW, stainless steel
- 1x bud ascent: SW
- 1x material ladder: SW, stainless steel, polyester-coated steel cable
- 1x island crossover: HPL, stainless steel, SW
- 1x post chain crossover: SW, stainless steel
- 1x seesaw beam crossover: SW, stainless steel
- 1x play board branch: HPL, macrolon, stainless steel
- 1x play board rotary colour disk: HPL, Macrolon, stainless steel
- 1x play board sound: HPL, polyester-coated steel cable, aluminium
- 1x play board puzzle: HPL
- 1x play board mirror: HPL, macrolon
- 1x frame trim: SW
- 1x roof: SW, HDPE
- 2x walk-through protection: polyester-coated steel cable, stainless steel
- 3x set of grips: steel



	Material	SW pi
	Foundation level	FL 1
	Minimum space	1296x969x517 cm
	Free falling height	245 cm
	Impact protection net	80,5 m ²
	Foundations	20x CF or 20x PFs
	Heaviest section	100 kg