

5 25 070 0110 0

unique play unit Lesla,  
solo







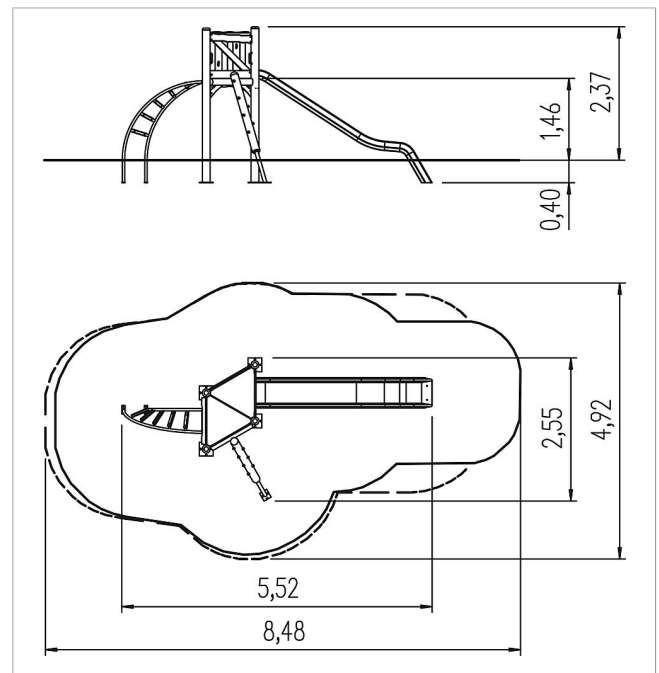

made in germany



### Scope of delivery

- 4x post construction: SW or steel
- 1x platform construction: galvanised steel
- 2x platform: HPL
- 3x wall panel: SW
- 1x bud ascent: SW
- 1x ladder twisted: stainless steel, SW
- 1x slide entry plate: HPL
- 2x set of grips: steel



	Material	SW pi
	Foundation level	FL 1
	Minimum space	848x492x337 cm
	Free falling height	145 cm
	Impact protection net	28,0 m <sup>2</sup>
	Foundations	7x CF or 7x PFs
	Largest section	275xØ 14 cm
	Heaviest section	25 kg