



5 11 528 0110 0

ecorino play unit Snowdon, solo







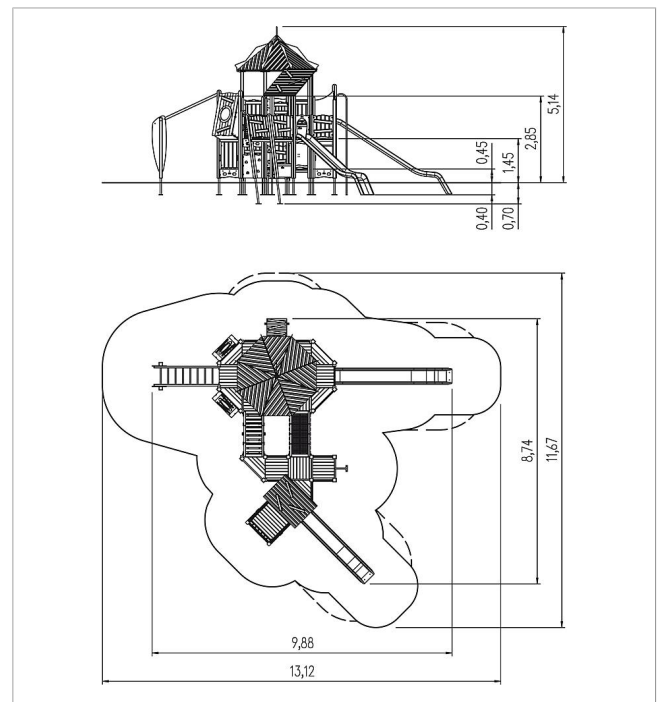

made in germany



Scope of delivery

- 12x adapter: SW or steel
- 2x post structure sloped: SW or steel
- 34x post structure: SW or steel
- 29x platform structure: SW
- 1x octagonal roof: SW, HPL, stainless steel
- 1x pent roof: SW
- 1x monkey bars: SW, stainless steel rung, HPL
- 1x climbing board: HPL, climbing grips
- 8x climbing board: HPL
- 1x vertical ladder: stainless steel
- 1x ramp: SW
- 1x fireman's pole: stainless steel
- 1x safety grid straight: SW, GFRP
- 1x suspension bridge sloped: SW, galvanised steel
- 1x crooked crossing: SW
- 1x net bridge straight: SW, plastic-coated steel cable
- 1x steps crossing: SW, HPL
- 2x 3D-parapet: HPL, SW, Makrolon
- 19x parapet: HPL
- 29x parapet: SW
- 8x walk-through protection: stainless steel
- 2x slide entry plate: HPL
- 3x access restriction: HPL
- 1x play panel click wheel: HPL, stainless steel, plastic
- 1x play panel hole: HPL, plexiglass
- 1x play panel wheel of dice: HPL, galvanised steel
- 1x play panel gearwheel: HPL
- 1x play panel abacus: HPL, ROB
- 1x decoration window: HPL, plexiglass
- 33x decoration timber: SW
- 8x set of grips: aluminium, plastic-coated
- 1x seating corner: SW
- 1x counter: SW, HPL
- fittings: stainless steel



	Material	SW pi
	Foundation level	FL 1
	Minimum space	1312x1167x514 cm
	Free falling height	285 cm
	Impact protection net	85,5 m ²
	Foundations	37x CF or 2x CF + 35x PFs
	Assembly	3 Personen/20 Std.
	Largest section	10x10x365 cm