



5 25 090 0410 0

unique quadruple swing Eagle with nest seat & swing seats







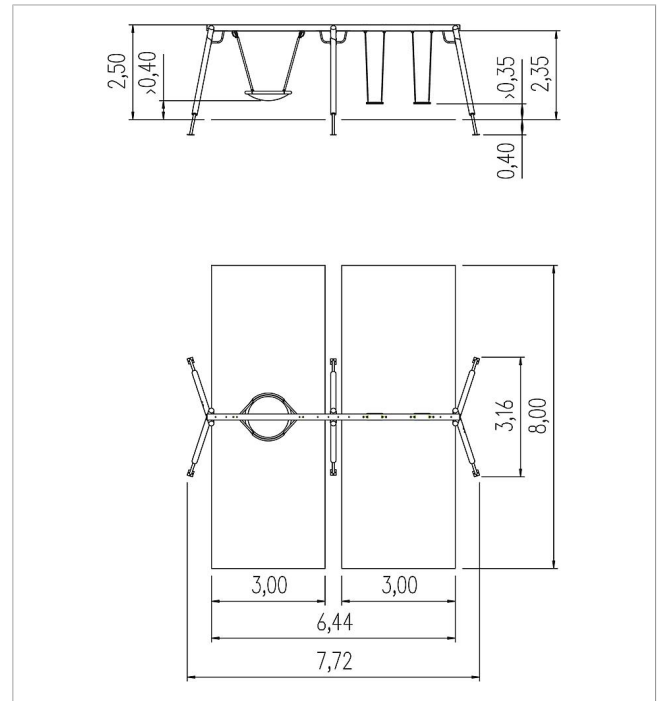

made in germany



Scope of delivery

- 1x swing frame: SW, galvanised steel
- 2x swing seat with chains: stainless steel, rubber
- 1x nest swing Ø 120 cm: rope ring, steel cable-link mat, rubber fabric over chain suspension
- 4x swing joint: galvanised steel
- 2x cardan joint: galvanised steel
- post shoes: galvanised steel



	Material	Larch GL
	Foundation level	FL 1
	Minimum space	800x772x380 cm
	Free falling height	149 cm
	Impact protection net	50,0 m ²
	Foundations	6x CF or 6x PFs + 6x CF
	Assembly	2 persons/4 h
	Largest section	650xØ 16 cm
	Heaviest section	60 kg