

5 25 091 0410 6

unique quadruple swing frame Eagle







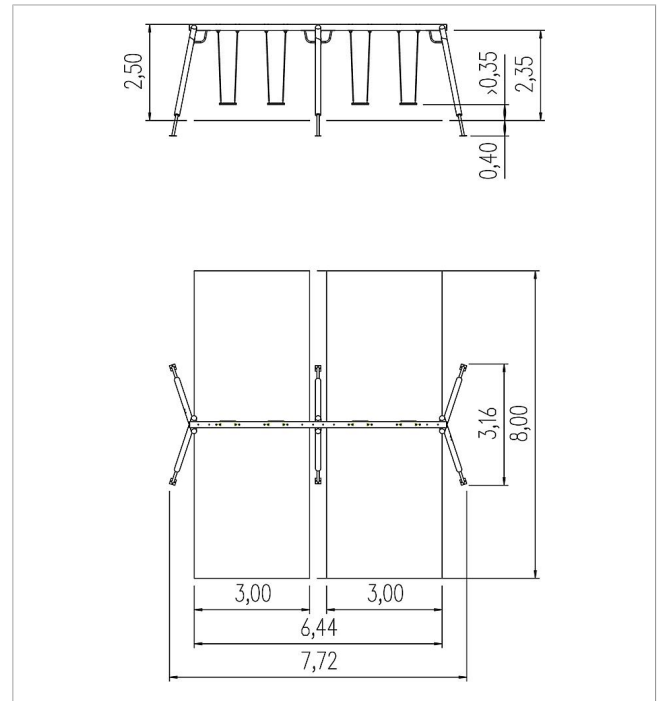

made in germany



Scope of delivery

1x swing frame: SW, galvanised steel
post shoes: galvanised steel



	Material	Larch GL green, Larch
	Foundation level	FL 1
	Minimum space	800x772x380 cm
	Free falling height	-
	Impact protection net	50 m ²
	Foundations	6x CF or 6x PFs + 6x CF
	Assembly	2 persons/4 h
	Largest section	650xØ 16 cm
	Heaviest section	60 kg