

5 55 118 0

Basis Rope tree Aerie with metal posts







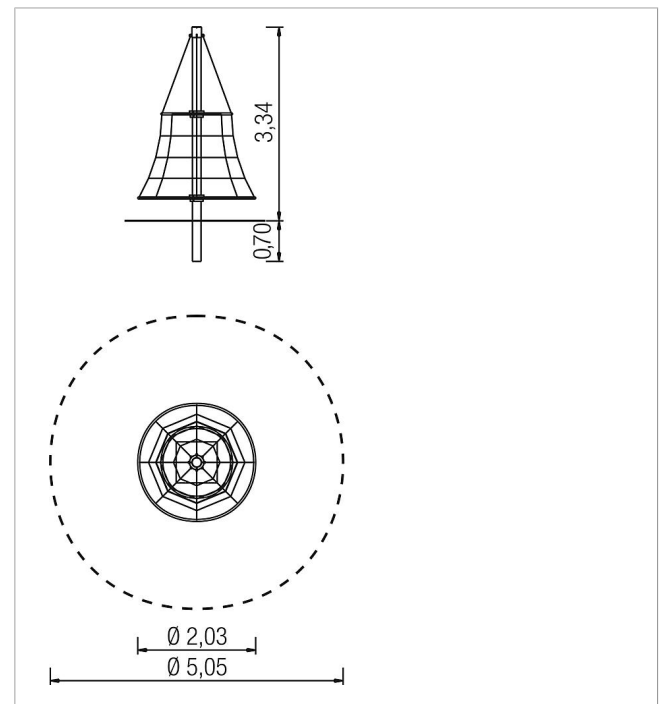

made in germany



Scope of delivery

1x rope tree eagle's nest: aluminium, plastic-coated steel cable



	Material	Steel
	Foundation level	FL 3
	Minimum space	Ø 505x387 cm
	Free falling height	187 cm
	Impact protection net	21,0 m ²
	Foundations	1x CF
	Assembly	2 persons/1.5 h
	Largest section	Ø 15x400 cm
	Heaviest section	60 kg