

5 56 071 0

Basis Roundabout with seats Jupiter Ø 200 cm







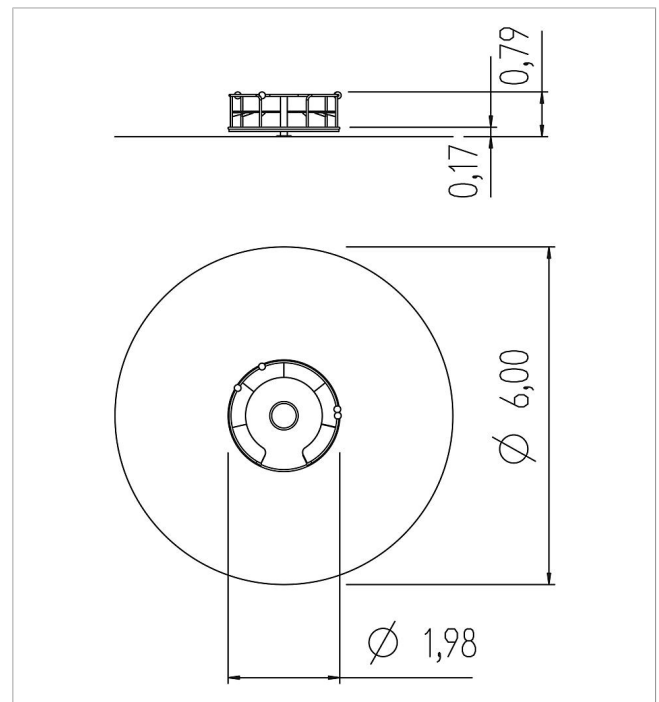

made in germany



Scope of delivery

- 1x mounting panel: stainless steel
- 1x bearing: Ball/conical roll bearing
- 1x basedplate Ø 195 cm: stainless steel, rubber
- 1x seat: HPL
- basic structure: stainless steel



	Material	Stainless steel
	Foundation level	FL 3
	Minimum space	Ø 600x280 cm
	Free falling height	45 cm
	Impact protection net	28,5 m ²
	Foundations	1x CF
	Assembly	2 persons/2 h
	Largest section	201x198x79 cm
	Heaviest section	225 kg