

5 11 026 0111 0

playo sand and mud play unit Ben







made in germany

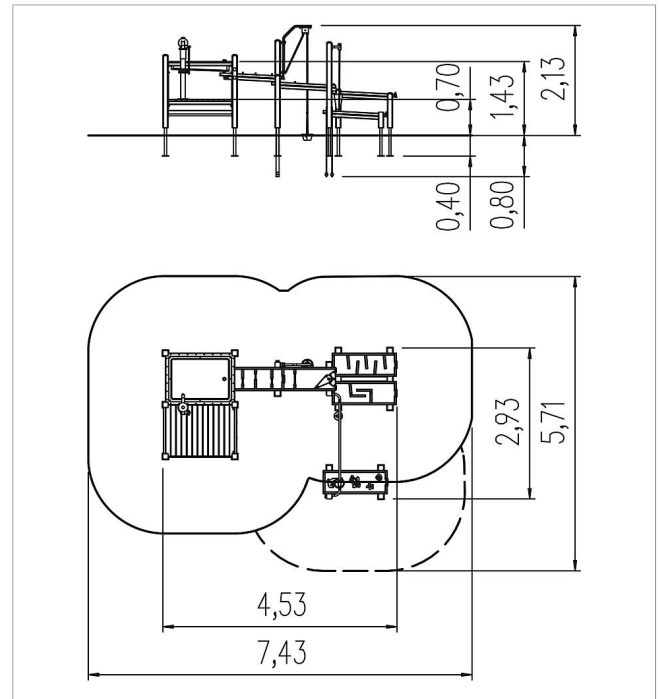

Scope of delivery

20x post construction: SW
 20x post shoe: steel galvanised
 1x platform construction: SW
 1x adapter: SW
 1x wall panel: HPL
 1x wall panel aqua: HPL
 5x aqua path: HPL, SW
 1x aqua-basin: HPL, SW, mud tray plastic
 3x walk-through protection leaf: stainless steel
 1x timber filler: SW
 1x set of grips: aluminium, plastic coated
 1x overhead conveyor: stainless steel, rubber
 1x climbing panel: HPL
 1x sand lift: stainless steel, rubber
 1x sand silo: stainless steel
 fittings: stainless steel
 designed for the supervised area



	Material	SW pi
	Foundation level	FL 1
	Minimum space	743x571x325 cm
	Free falling height	145 cm
	Impact protection net	31,5 m ²
	Foundations	20x CF or 14x PFs + 3x CF