

5 11 031 0111 0

playo sand and mud play unit Moritz







made in germany

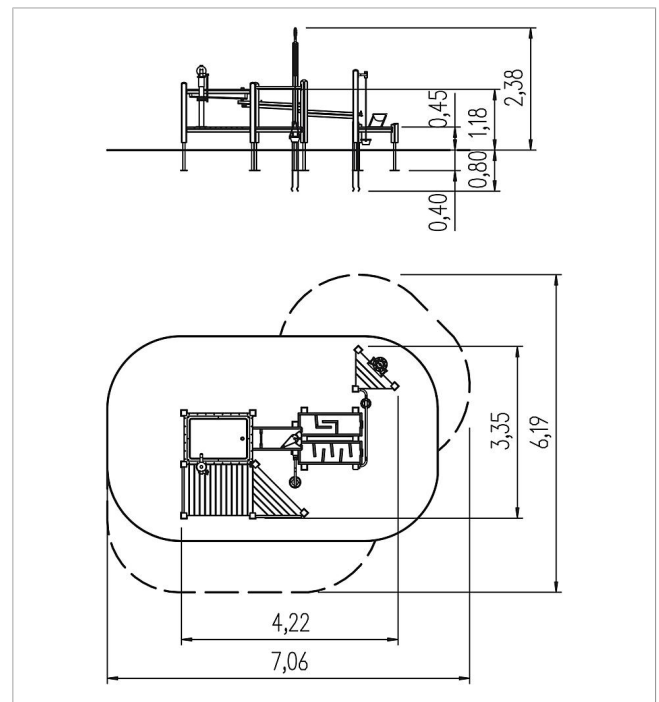

Scope of delivery

18x post construction: SW
 18x post shoe: steel galvanised
 3x platform construction: SW
 3x adapter: SW
 3x aqua path: HPL, SW
 1x aqua-basin: HPL, SW, mud tray plastic
 1x wall panel aqua: HPL
 2x walk-through protection leaf: stainless steel
 1x timber filler: SW
 1x overhead conveyor: stainless steel, rubber
 1x sand lift: stainless steel, rubber
 1x sand sieve: stainless steel
 fittings: stainless steel
 designed for the supervised area



	Material	SW pi
	Foundation level	FL 1
	Minimum space	706x619x298 cm
	Free falling height	118 cm
	Impact protection net	24,0 m ²
	Foundations	18x CF or 14x PFs + 2x CF