

5 10 039 0111 0

playo sand building
site Green Woodpecker







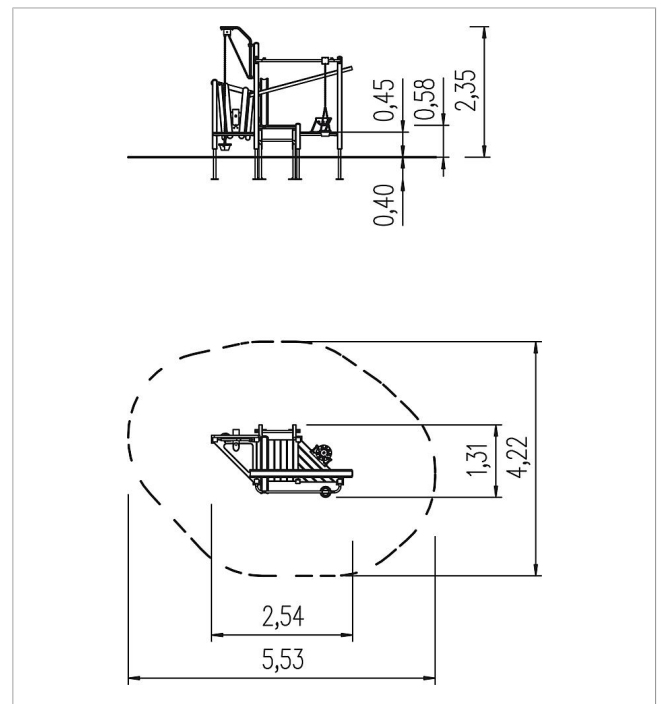

made in germany

2+

Scope of delivery

set of posts with post bases: SW, galvanised steel
 set of platforms: SW
 platform with sifter insert: SW, stainless steel
 suspended track: stainless steel, PAH-free rubber
 sand sifter: stainless steel
 sand crane: stainless steel, PAH-free rubber
 sand chute assembly: SW
 ladder ascent: SW
 sand pouring pipe: plastic, HPL, SW
 mounting accessories, article passport



	Material	SW pi
	Foundation level	FL 1
	Minimum space	553x422x235 cm
	Free falling height	58 cm
	Impact protection net	18,5 m ²
	Foundations	8x CF or 6x PFs
	Assembly	2 persons/5 h
	Largest section	75x75x6 cm
	Heaviest section	10 kg