

5 66 312 5

unique sand wreck Bounty Mast







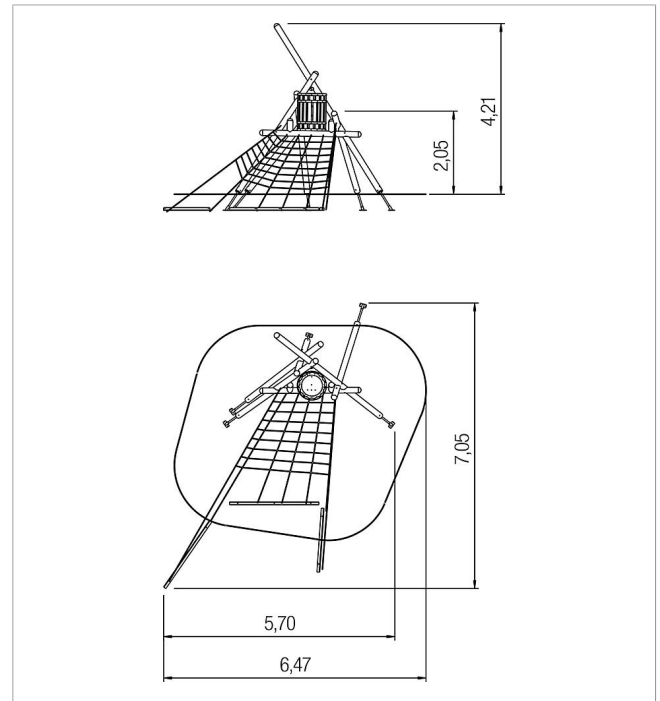

made in germany



Scope of delivery

1x net: plastic-coated steel cable
1x barrel: SW
1x fog horn: PVC
post shoes: galvanised steel
wood structure: SW



	Material	SW pi
	Foundation level	FL 1
	Minimum space	647x705x421 cm
	Free falling height	205 cm
	Impact protection net	28,5 m ²
	Foundations	1x CF or 5x PFs + 4x PFI
	Assembly	2 persons/6 h
	Largest section	531xØ 14 cm
	Heaviest section	65 kg