

5 66 311 5

unique sand wreck Bounty Stern







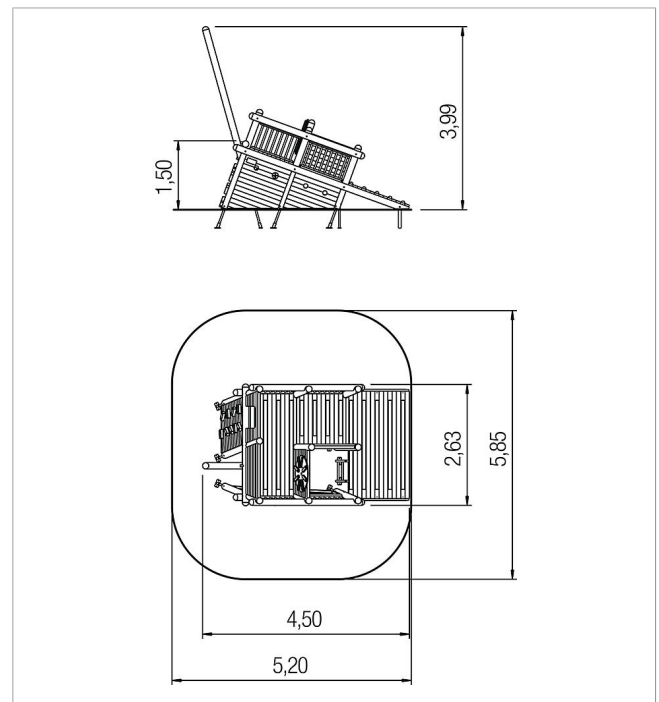

made in germany



Scope of delivery

1x ship bell: brass
 1x engraved sign: brass
 1x ladder access: ash, SW
 1x steering wheel: HPL
 post shoes: galvanised steel
 wood structure: SW



	Material	SW pi
	Foundation level	FL 1
	Minimum space	520x585x399 cm
	Free falling height	150 cm
	Impact protection net	27,0 m ²
	Foundations	1x CF or 14x PFs
	Assembly	2 persons/6 h
	Largest section	140x234x11 cm
	Heaviest section	75 kg