

5 55 097 0330 0

unique seesaw, non-bump







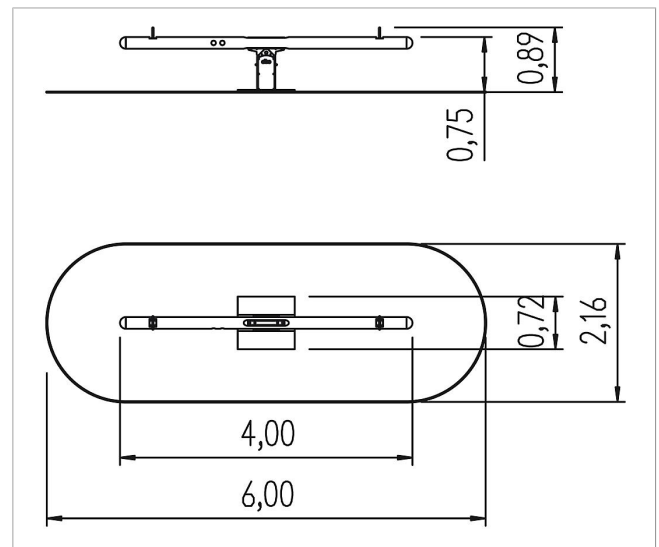

made in germany



Scope of delivery

- 1x see-saw beam: SW
- 2x handle: steel powder-coated
- 1x see-saw base: galvanised steel, stainless steel, HPL
- 2x fall protection edge panels



	Material	Larch nature
	Foundation level	FL 3
	Minimum space	600x216x305 cm
	Free falling height	125 cm
	Impact protection net	12,0 m ²
	Foundations	1x CF
	Assembly	2 persons/2 h
	Largest section	400xØ 16 cm
	Heaviest section	60 kg