



5 55 363 024

unique Single Curver







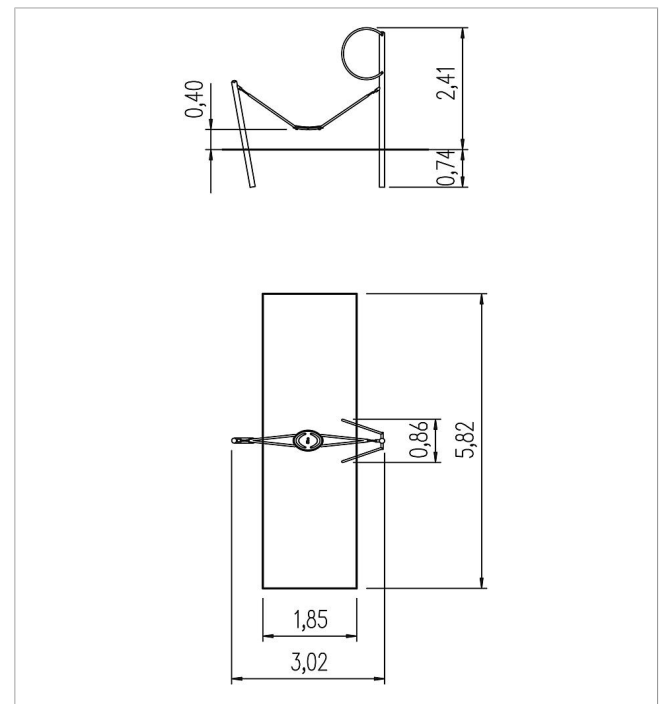

made in germany



Scope of delivery

- 2x posts: galvanised and powder-coated steel
- 1x chain: galvanised steel
- 2x joint: stainless steel
- 1x curver seat: rubber, galvanised steel
- 2x holding bracket: stainless steel



	Material	Steel powder. blue
	Foundation level	FL 3
	Minimum space	300x582x265 cm
	Free falling height	85 cm
	Impact protection net	11,0 m ²
	Foundations	2x CF
	Assembly	2 persons/2 h
	Largest section	312x85x86 cm
	Heaviest section	80 kg