

5 55 133 5

## unique six-bay swing with tyre seats







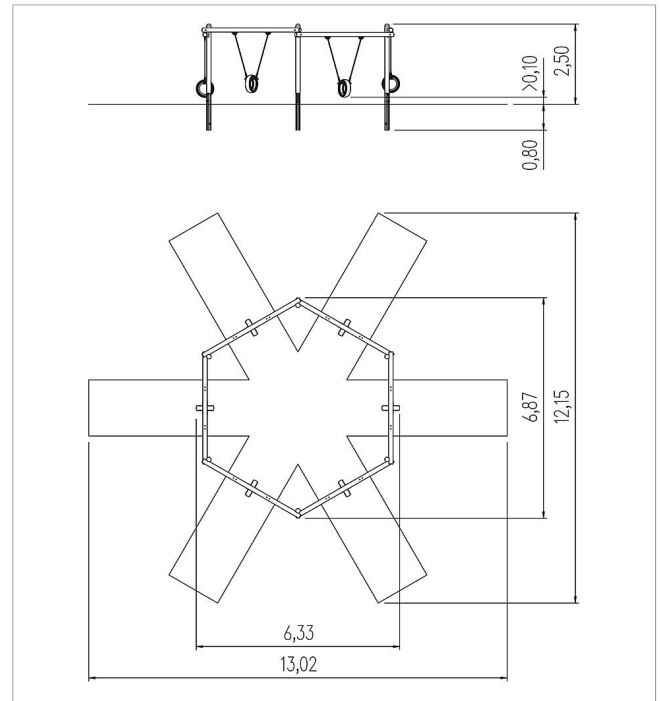

made in germany



### Scope of delivery

- 1x swing frame: SW
- 6x tyre seats with chain: galvanised steel, rubber
- 12x swing-guided: steel
- post shoes: galvanised steel



	Material	SW pi
	Foundation level	FL 3
	Minimum space	1302x1215x328 cm
	Free falling height	148 cm
	Impact protection net	60,5 m <sup>2</sup>
	Foundations	6x CF
	Assembly	3 persons/4 h
	Largest section	348xØ 140 cm
	Heaviest section	30 kg