



5 11 501 7110 0

**ecorino slide ascent PH
145, solo**







made in germany

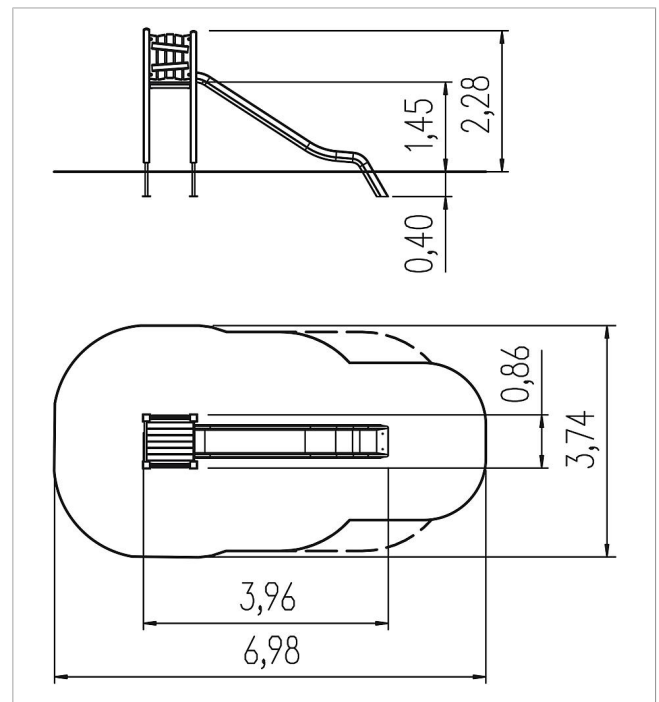

Scope of delivery

4x post construction: SW or steel
 4x post shoe: steel galvanised
 1x platform construction: SW
 2x wall panel wood: SW
 4x decoration crossbar: SW
 1x walk-through protection leaf: stainless steel
 1x set of grips: aluminium, plastic coated
 2x cord protection: HPL
 1x ladder vertical: SW, rungs stainless steel
 1x slide entry plate: HPL
 fittings: stainless steel



	Material	Stainless steel, SW pi
	Foundation level	FL 1
	Minimum space	698x374x325 cm
	Free falling height	145 cm
	Impact protection net	21,5 m ²
	Foundations	4x CF or 4x PFs
	Assembly	2 persons/6 h