



5 58 424 0

Basis Slide with ladder steel, ph 150 cm







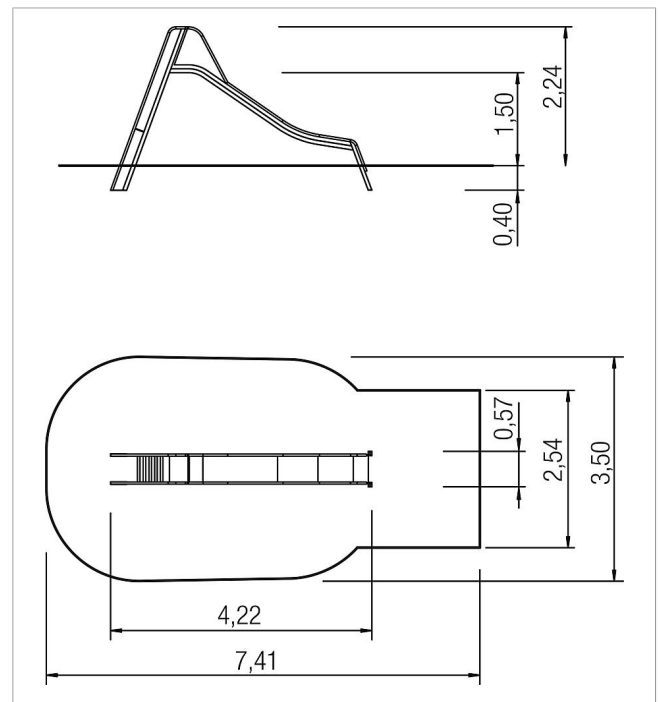

made in germany



Scope of delivery

1x slide PH 150 cm: steel galvanised and painted with stainless steel lining
1x slide ascent: galvanised steel



	Material	Steel
	Foundation level	FL 1
	Minimum space	741x350x330 cm
	Free falling height	150 cm
	Impact protection net	22,0 m ²
	Foundations	2x CF
	Assembly	1 person/1 h
	Largest section	330x50x70 cm
	Heaviest section	100 kg