



5 60 445 0

basis Sound island Calypso





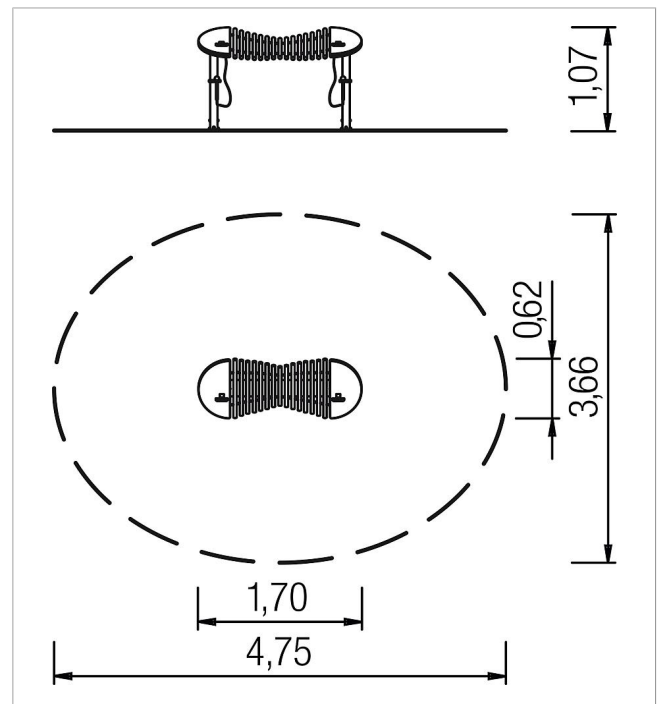

made in germany

3+

Scope of delivery

1x sound island Echo Piano: powder-coated steel, stainless steel (V2A), polyethylene sheet (HDPE)



| | | |
|-------------------------------------------------------------------------------------|-----------------------|--------------------------------------------|
|  | Material | Powder-coated steel, stainless steel, HDPE |
|  | Foundation level | FL 3 |
|  | Minimum space | 470x362x180 cm |
|  | Free falling height | - |
|  | Impact protection net | - |
|  | Foundations | 2x CF |
|  | Largest section | 170x62x107 cm |