

5 60 452 0

basis Sound island Echo II





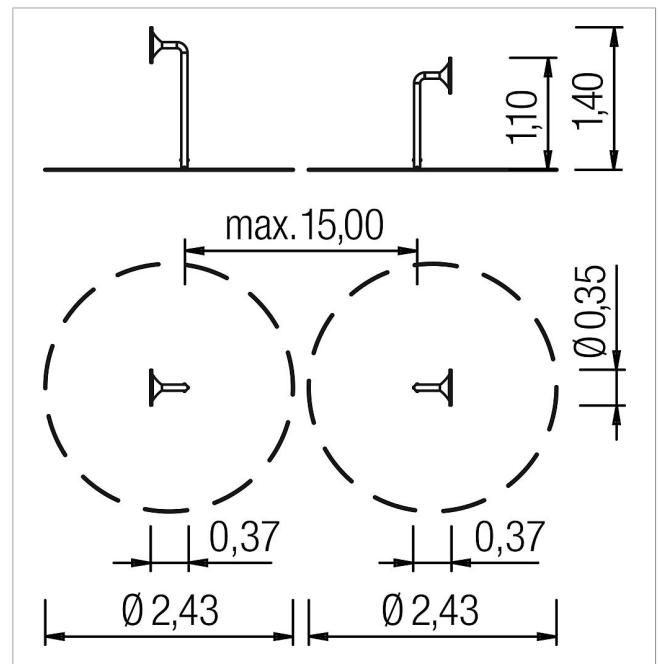

made in germany

3+

Scope of delivery

1x sound island Echo II: powder-coated steel, polyethylene sheet (HDPE)
1x rubber hose 15m: plastic



	Material	Powder-coated steel, plastic, HDPE
	Foundation level	FL 3
	Minimum space	335x335x180 cm
	Free falling height	-
	Impact protection net	-
	Foundations	2x CF
	Largest section	35x35x140 cm