



5 60 447 0

basis Sound island Koala





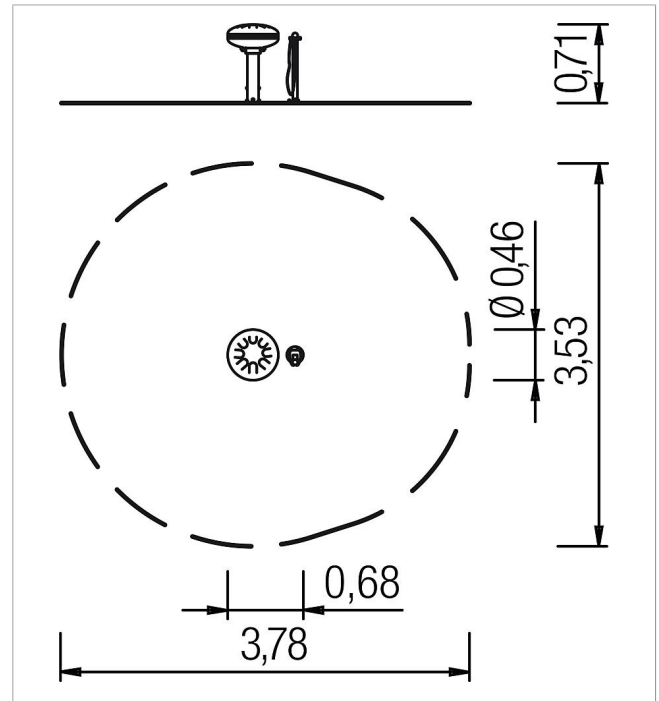

made in germany

3+

Scope of delivery

1x sound island Koala: powder-coated steel, stainless steel (V2A), polyethylene sheet (HDPE)



	Material	Powder-coated steel, stainless steel, HDPE
	Foundation level	FL 3
	Minimum space	412x412x180 cm
	Free falling height	-
	Impact protection net	-
	Foundations	2x CF
	Largest section	112x112x60 cm